

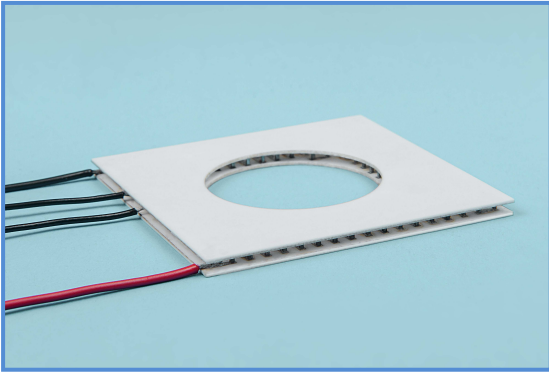

ENGINEERING & PRODUCTION

# Thermoelectric Cooling Module

## TECB-66-156-3-(14.4-1.2-10)-46-69-CH



Performance specifications		
Hot side temperature Th (°C)	27	50
$\Delta T_{max}$ (°C)	69	79
Qmax (Watts)	10	11.1
I <sub>max</sub> (Amps)	1.2	1.2
V <sub>max</sub> (Volts)	14.4	16.3
Module resistance (Ohms)	10	10.8

### Drawing

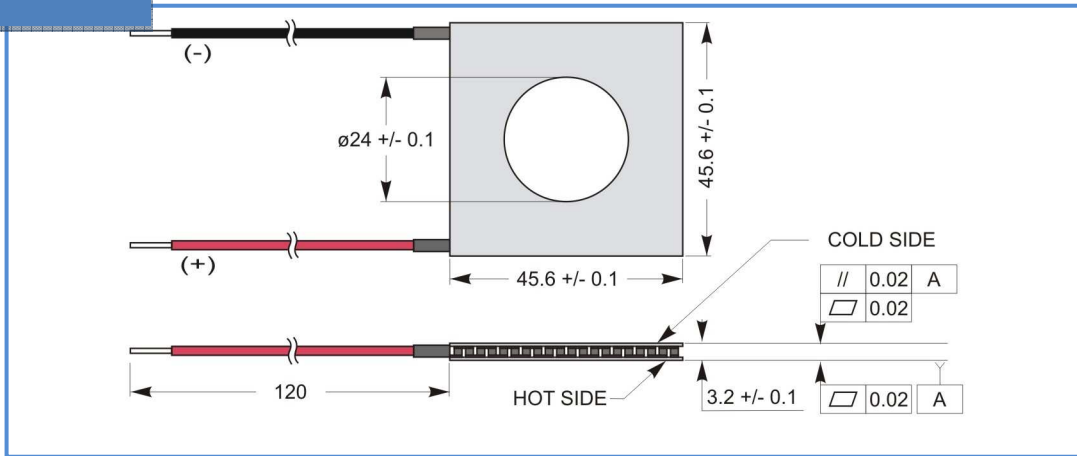

### Performance Graphs at Th=25°C

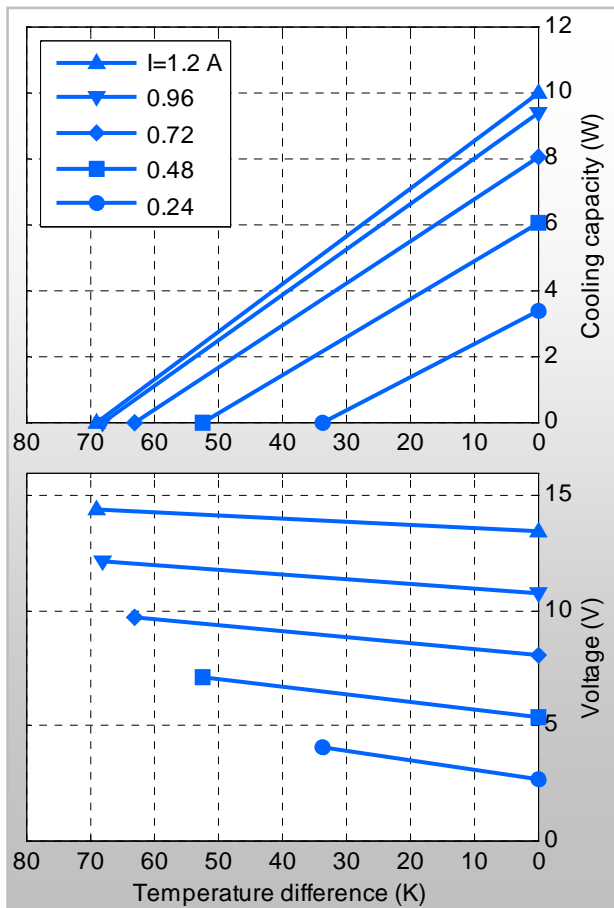

### Performance Graphs at Th=50°C

